



HiMSEN Engine

Hi-touch Marine & Stationary Engine

H25/33V



HiMSEN family has been successfully launched into the market since 2001 thanks to support and cooperation from many owners, shipyards and classification societies. We would like to express our sincere gratitude to the everyone involved in this enterprise. And we hope that you have good business with our HiMSEN engines.



» Introduction

The HiMSEN H25/33V engine has been developed based on common philosophy of HiMSEN engine with smart, simple and robust. And the new engine has same bore/stroke and design concept as the current H25/33 in-line engine which is well proven in the market. The high power density contribute to easy and space-saving marine and stationary applications. The most advanced Hi-touch technologies are applied in this engine so that the engine has the excellent performance, low fuel consumption and low emission and so on. HiMSEN H25/33V medium speed engine marks the birth of a new era in earth-friendly engines, boasting a compact structure and simple & stylish exterior.

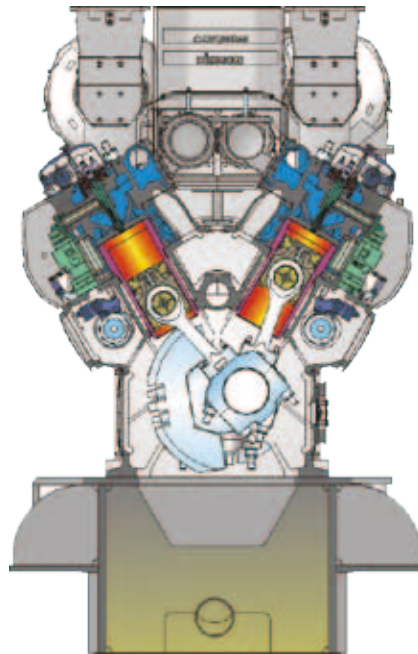

H25/33V Cross Section

■ Technical Data (Based on Marine Genset)

No. of Cylinders	-	12, 14, 16, 18, 20
Rated Speed	rpm	900 / 1000
Power Per Cylinder	kW	340
Cylinder Bore	mm	250
Piston Stroke	mm	330
Mean Piston Speed	m/s	9.9 / 11.0
Mean Effective Pressure	bar	28.0 / 25.2
Compression Ratio	-	17 : 1
Specific Fuel Oil Consumption*	g/kWh	183

* The SFOC is based on without engine driven pumps and tolerance +5 %

Emission Control Technology

» IMO Tier II technologies

The HiMSEN H25/33V engine has countermeasures to meet IMO Tier II regulations with advanced simulation and measurement by using of enhanced miller timing and optimized combustion. The enhanced miller timing with new turbochargers which has higher pressure ratio enables to get benefit in SFOC and lower combustion temperature which is critical in formation of NO_x emission.

Furthermore, controlled combustion with optimum combination of the piston bowl shape and F.O Nozzle's specification helps to reduce NO_x emission.

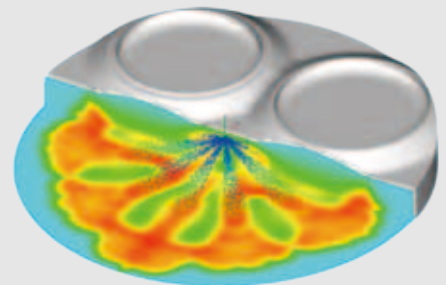
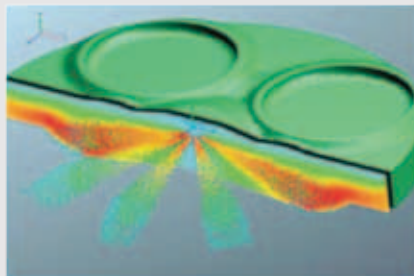
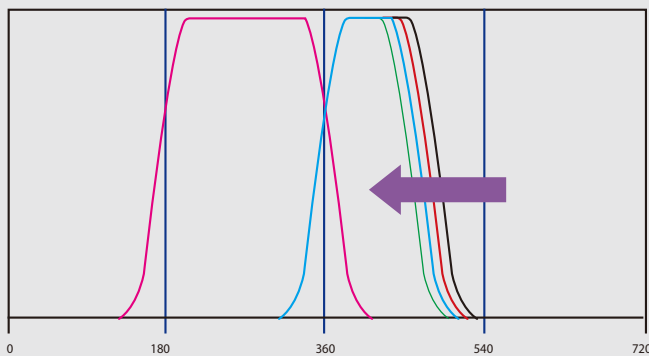

» IMO Tier III technologies

HHI is already preparing many measures for IMO Tier III. Some of them have already been developed such as Selective Catalytic Reduction (SCR) and Scrubber. Newly developed SCR can reduce NOx emission by upto 95% to meet IMO Tier III regulation.

Optimized application depending on customer's requirement is possible including whole installation, performance and engine with low cost and satisfaction.

Exhaust gas scrubbing is an alternative solution for high sulphur content fuels to reduce SOx emissions, and HHI can supply the best Scrubber in the world market.

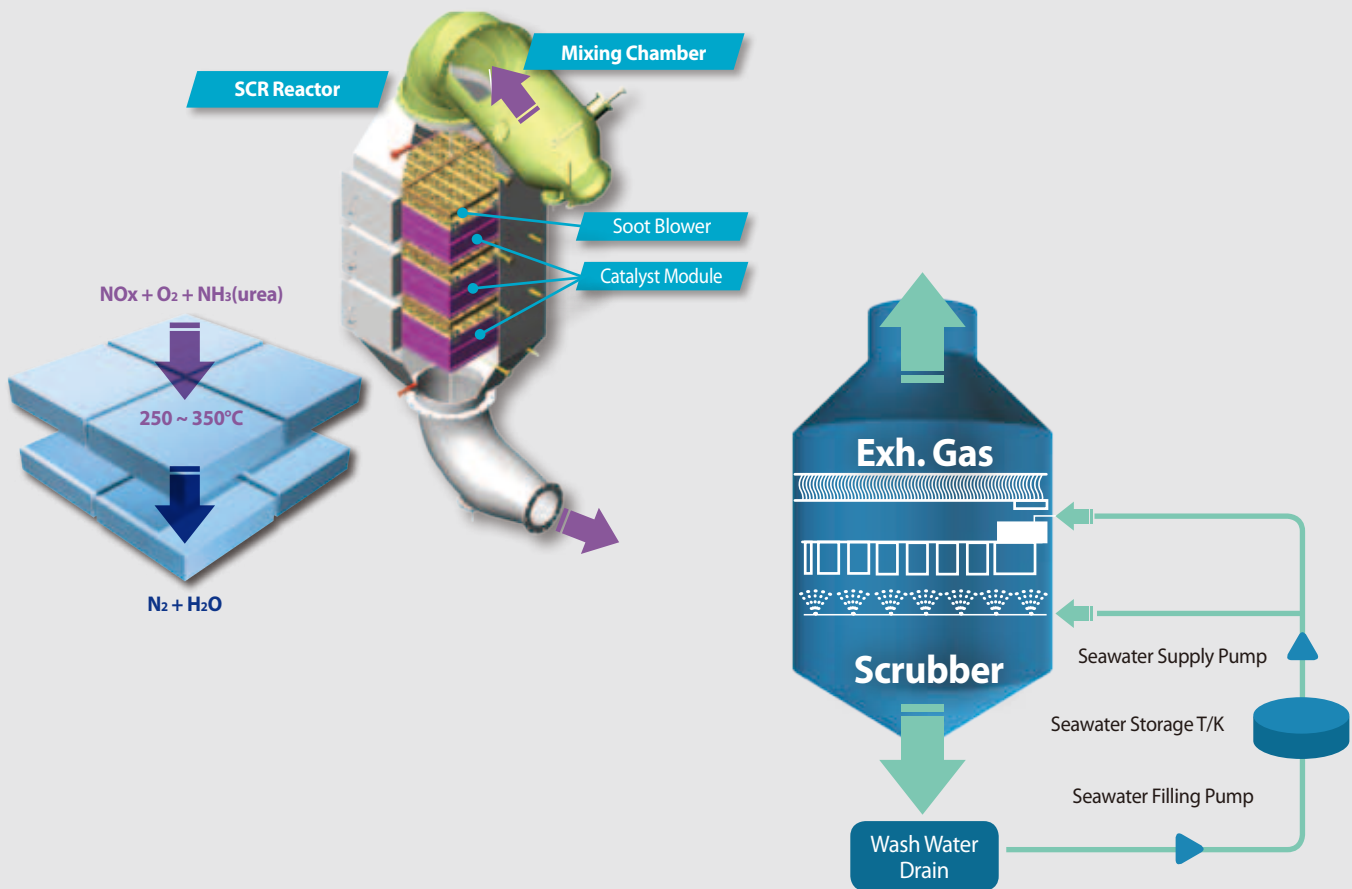

» Main Features

Performance characteristics

- Higher output than similar engines
- Low fuel oil consumption
- Quick acceleration & load response

Maintenance

- Modularized design for easier maintenance
- Minimal the number and kind of components

Earth-friendly engine

- Low NOx emissions
- Complies with IMO Tier II
- Low Vibration & Noise

Main application

- Marine propulsion and generating sets
- Power plants

»» Engine Block

The engine block is made of monoblock cast iron and has the combustion air chamber and lubricating oil channel. There is no need for maintenance normally except for cleaning in side air chamber and outside. And also this is of stiff and reliable to internal and external forces.

The main bearing and main bearing cap for the underslung crankshaft are carried in heavy duty supports tightened hydraulically by two vertical main bearing studs and two horizontal side studs.

There are covers for maintenance and access to the crankshaft including connecting rod and camshaft with swing arm for each cylinder. Furthermore, some of crankcase covers are mounted with relief valves complying with classification societies requirement and these will open if oil vapors in the engine block are ignited.

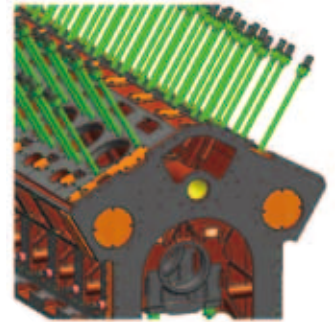

»» Crankshaft

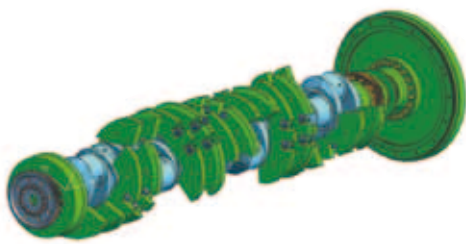

The crankshaft is made of CGF (Continuous Grain Flow) die-forged special alloy steel with high tensile strength. The design of the crankshaft satisfies the requirements of all classification societies.

The crankshaft has a counterweight for balancing the mass forces on each crank web, which is fastened with two hydraulically tensioned studs.

At the free end there is a gear wheel connected to lub. oil, cooling water pumps. A vibration damper will be mounted depending on the result of torsional vibration calculation for each project. At the opposite end (flywheel end) the crankshaft has a gear wheel for camshaft driving and a coupling flange to transmit the engine power.

»» Connecting Rod

The connecting rod is made of special die-forged steel, which is composed of a three-piece 'marine head' type. All fasteners are tightened by hydraulic tension for better reliability and maintenance. The careful investigation with the advanced finite element analysis has been completed in order to optimize the geometries and enhance the durability.

The 'marine head' type connecting rod can provide the easy maintenance without removing the big end part of connecting rod and cylinder liner which reduces the working time and cost.



»» Main Bearing

The suitable bearing load and oil film thickness is realized by using of advanced CFD (Computational Fluid Dynamics) analysis and the special running layer with excellent corrosion resistance is applied.



»» Camshaft

The camshaft is of a split type for each cylinder. And each camshaft is jointed by screws. Each piece of camshaft has a fuel cam, an intake cam and an exhaust cam. The surface hardening is done for the each cam profile.

Furthermore, the fuel cam with high load is located very close to the camshaft bearing. The gear wheel for driving the camshaft as well as the gear wheel for connection of governor drive are mounted on the flywheel side.

The extreme miller timing for intake cam has been applied to reduce NOx emissions.



»» Piston & Piston Rings

The piston is of composite type with steel crown and nodular cast iron skirt. Cooling of piston is done by engine's lubricating oil and cocktail shaking principle is applied. It has two compression rings and one spring loaded oil scraper ring. The piston ring grooves are hardened and first compression ring is side-coated for excellent wear resistance and for low fuel consumption.



»» Cylinder Head

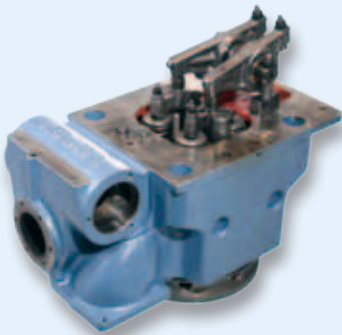

The cylinder head has been designed taking the thermal load distributions and the maximization of flows for charge air, exhaust gas into considerations.

The cylinder head is made of ductile cast iron and has cast-in passages for cooling water, intake air and exhaust gas. The cylinder head also has drilled holes for supplying lube oil to valve drives from engine block.

The robust structure of the cylinder head design provides suitable and uniform sealing between the cylinder head and cylinder liner. The cylinder head unit including rocker arms can be dismantled without removing the all of connections. It is tightened by means of four hydraulic studs which are screwed into the engine block.

»» Cylinder Liner & Flame Ring

The cylinder liner is made by centrifugally cast of a special cast iron for good wear resistance and high strength and fitted in a bore in the engine block. The liner is fixed by cylinder head and seated on the water jacket. The wall thickness of top part for liner is optimized for both the resistance from the combustion force and the effective cooling.

The lower part of the liner is uncooled in order to maintain the suitable temperature for preventing the cold corrosion. So there is no water in the engine block.

To reduce bore polishing and lubricating oil consumption, the flame ring is fitted on the top of the cylinder liner.



» Front End Block

The front end block is located on the free end of the engine. Pipes for cooling water and lubricating oil system as well as pumps are modularized to simple casting structure.

The modularized front end block provides the direct accessibility and the easy maintenance for auxiliary parts.

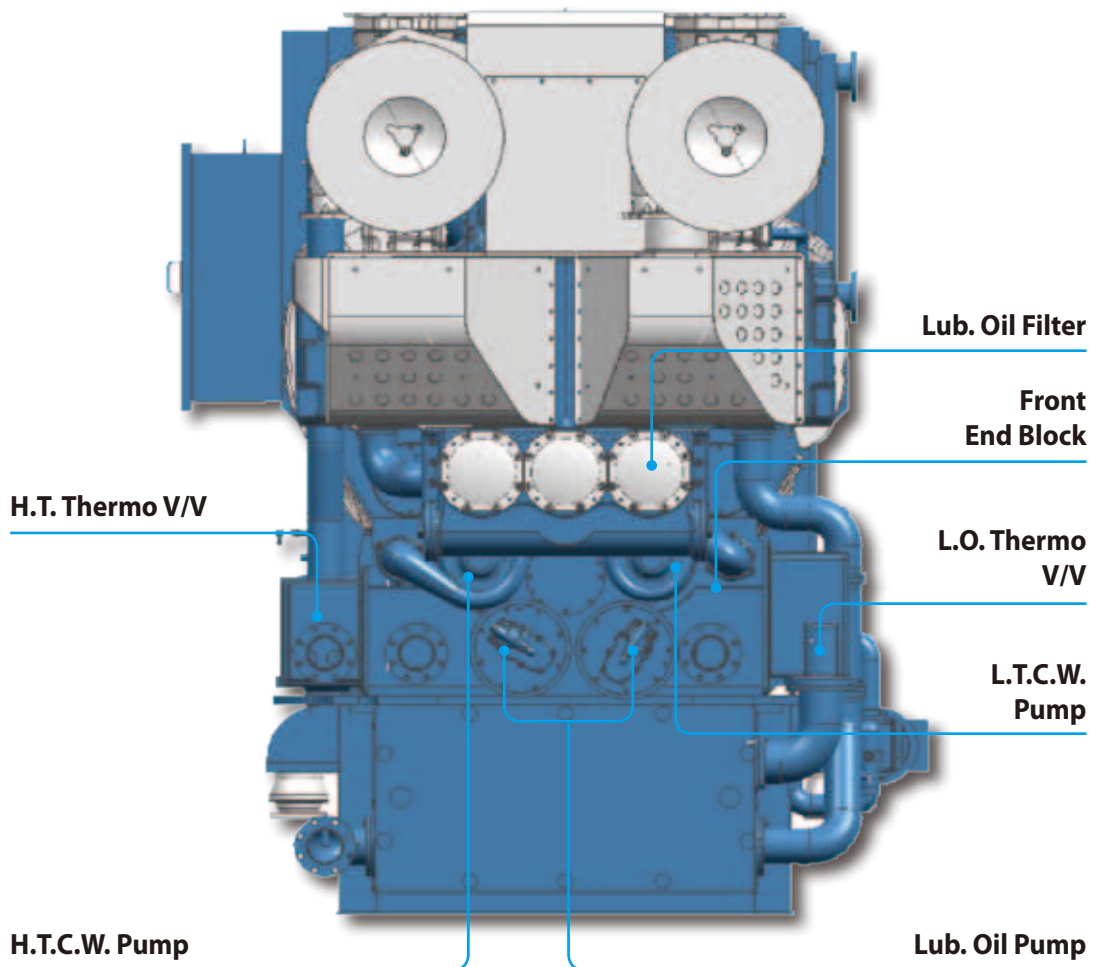

» Air and Exhaust Gas System

The new generation turbocharger with high compression ratio, applied for enforced international environment regulations, IMO NO_x limit.

The MPC (Modular Pulse Converter) exhaust system is applied by considering better performance within the limited space of Vee-type engine.

The compact 2-Stage charge air cooler with a large cooling surface is applied and the charge air receiver is designed for the minimum pressure variation and the excellent breathing of engine.

» Engine Automation

HiMSEN Gen-sets provide automation system for engine safety, control and indicating based on programmable logic controller. The system is independently installed in each engine and also can be connected to the remote system, for example main switch board of engine control room via hard wired communication cables.

In addition to fulfilling the requirements of all classification societies and IACS, the system provides more friendly features to customers.

For example,

- Compact size and easy installation
- Digital display (Engine & T/C RPM)
- Simple operation and no maintenance free

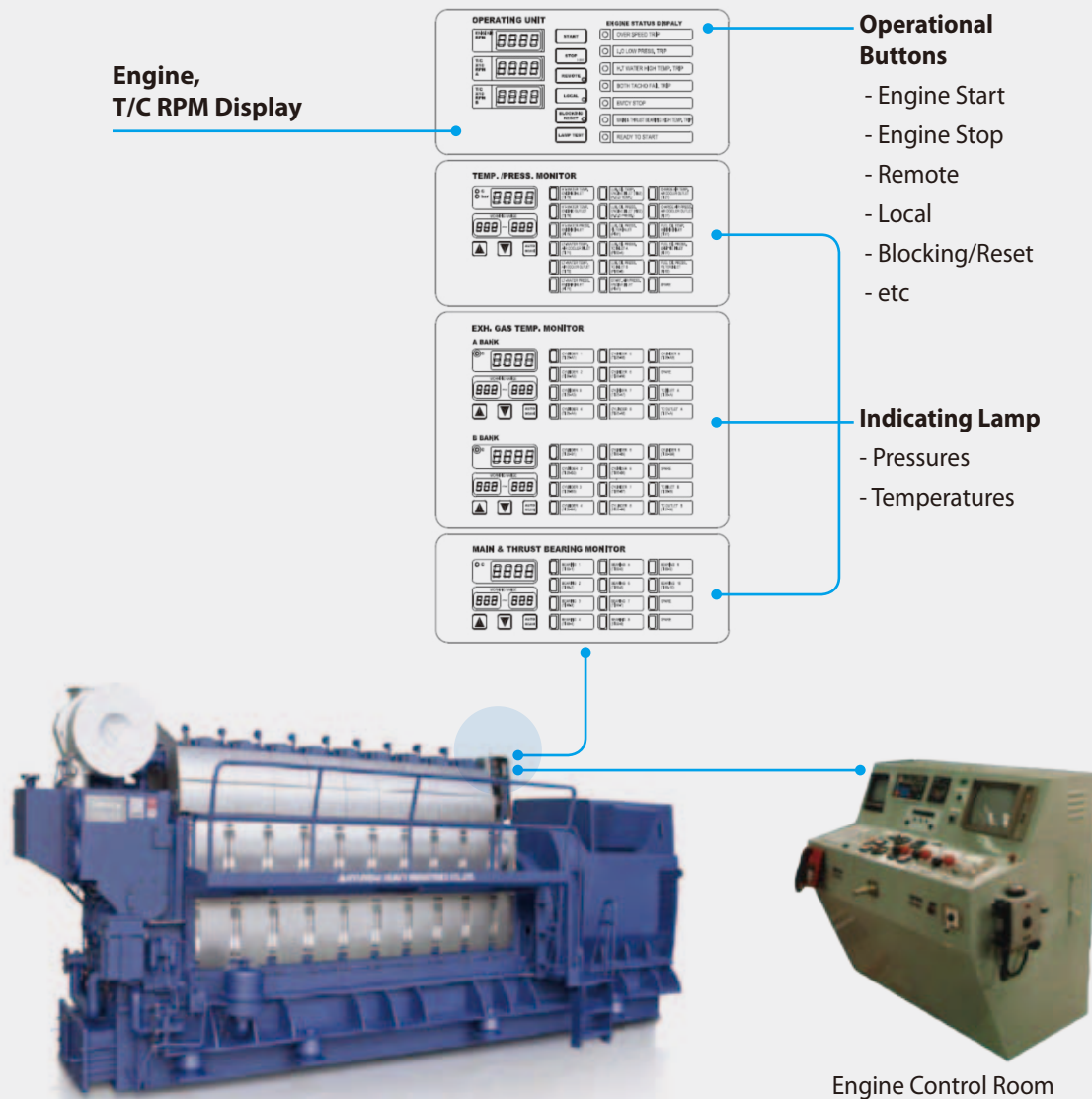

■ Rated Output of Gen-Set at 100% load

Engine Type	900 rpm / 60Hz, 1000 rpm / 50 Hz			
	Marine Application		Stationary Application	
	Engine	Generator	Engine	Generator
12H25/33V	4,080	3,917	3,840	3,686
14H25/33V	4,760	4,570	4,480	4,301
16H25/33V	5,440	5,222	5,120	4,915
18H25/33V	6,120	5,875	5,760	5,530
20H25/33V	6,800	6,528	6,400	6,144

Remark

- The Generator outputs are calculated by an efficiency of 96% and a power factor of 0.8 lagging.

■ Dimensions & Weights

Gen-set for 900 / 1000 rpm

Engine Type	Dimensions (mm)				Dry Weight (ton)	
	A	B ¹⁾	C ¹⁾	H	Engine ²⁾	Genset ^{1) 3)}
12H25/33V	5,524	3,334	8,858	3,750	33.5	58.2
14H25/33V	5,944	3,504	9,448	3,750	36.5	63.4
16H25/33V	6,364	3,682	10,046	3,750	39.5	69.6
18H25/33V	6,784	3,772	10,556	3,750	42.5	77.5
20H25/33V	7,204	3,727	10,931	3,750	45.5	79.5

Remark

1) Depending on alternator.

2) Without common base frame.

3) With common base frame & alternator (Maker : HHI-EES).

D : Min distance between engines 3,840 mm (with gallery).

P : Free passage between the engines, width 600 mm and height 2,000 mm.

Note) All dimensions and weight are approximate value and subject to change without prior notice.

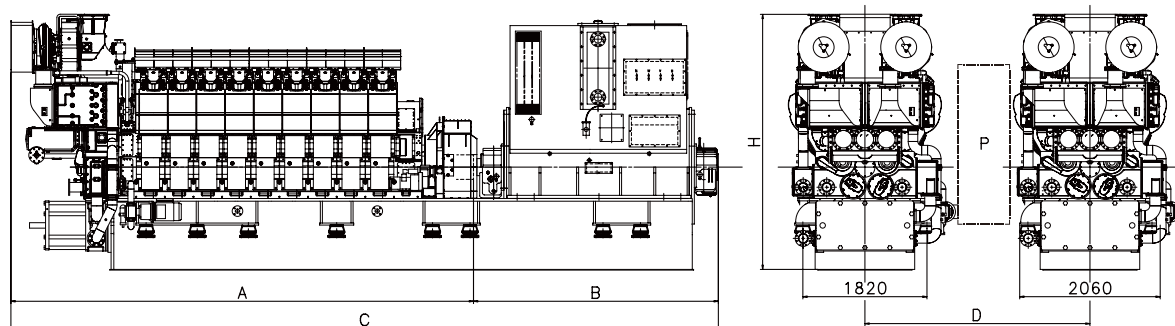

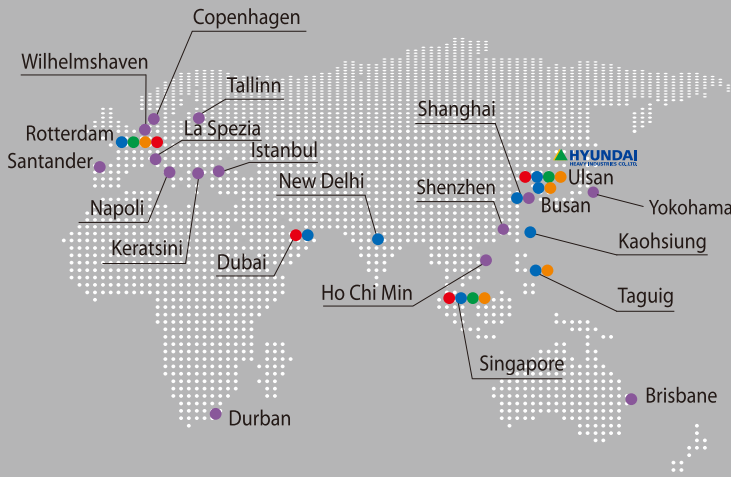

- HHI-EMD Direct Service Center
- Authorized Repairer
- Cooperative Repairer
- Spare Parts Depot
- Parts Sales Agent

Global Service Network

Engine CS Department

Management Board

K.H. Kim,
Senior Vice President
Tel : +82 52 202 0252
E-mail : kimkh@hhi.co.kr

J.R. Son,
Senior Vice President
Tel : +82 52 202 0704
E-mail : jrson@hhi.co.kr

Parts Sales Team

Hyoung-Log Oh,
Team Leader
Tel : +82 52 202 7411
E-mail : enginecs@hhi.co.kr

Technical Service Team

Kyong-Uk Song,
Team Leader
Tel : +82 52 202 7412
Email : kusong@hhi.co.kr

2-Stroke Service Team

Ahn-Min Kim,
Team Leader
Tel : +82 52 202 7418
E-mail : amkim@hhi.co.kr

Department Head

Seon-Gun Cha,
General Manager
Tel : +82 52 202 7411
E-mail : enginecs@hhi.co.kr

HiMSEN Service Team

Sung-Lim Choi,
Team Leader
Tel : +82 52 202 7313
E-mail : slchoi@hhi.co.kr

Power Plant Service Team

Ho-Jeong Song,
Team Leader
Tel : +82 52 202 7583
E-mail : hjdpp@hhi.co.kr

CS Planning Team

Jae-Ho Jung,
Team Leader
Tel : +82 202 7586
E-mail : kevin@hhi.co.kr

Direct Service Center

Korea

1000, Bangeojinsunhwan-doro,
Dong-gu, Ulsan, Korea
Hyundai Heavy Industries Co.,
Ltd.
Engine & Machinery Division
Engine Customer Service
Department
Tel : +82-52-202-7411
E-mail : enginecs@hhi.co.kr

Netherlands

Folkert Elsingastraat 7
3067NW, Rotterdam
The Netherlands
Tel : +31-10-212-1567
E-mail : jsyi@hhi.co.kr

Singapore

#41-02 Suntec Tower One
7 Temasek Blvd.
Singapore 038987
Tel : +65 6 337 2366
E-mail : engineas@hhisgp.co.kr

UAE

Unit 205, Emaar Square
Building 4
Sheikh Zayed Road
Dubai, U.A.E 252458
Tel : +971 4 425 7995
E-mail : sugwon@hhi.co.kr



www.hhi.co.kr
www.hyundai-engine.com

We build a better future
 **HYUNDAI**
HEAVY INDUSTRIES CO.,LTD.
ENGINE & MACHINERY

1000, Bangeojinsunhwan-doro,
Dong-gu, Ulsan, Korea

Engine Sales Department(Domestic)
Tel: 82-52-202-7291~9
Fax: 82-52-202-7300
E-mail: k110@hhi.co.kr

Engine Sales Department(Export)
Tel: 82-52-202-7281~9
Fax: 82-52-202-7427
E-mail: k150@hhi.co.kr

Diesel Power Plant Sales Department
Tel: 82-52-202-7301~7310
Fax: 82-52-202-7202
E-mail: k120hhi@hhi.co.kr